

NOM DU PROJET

TYPE

QTÉ



RIO

- Alliage d'aluminium
- Plusieurs longueurs disponibles
- Angle de rotation: 110°
- Tension d'entrée: 100~240VAC
- Tension de fonctionnement: 24VDC
- Classé IP65
- Température de fonctionnement: -20°C to 40°C

Sujet à une quantité minimum pour commander. Contactez-nous pour plus d'informations.



3 ans de garantie



Durée de vie +50 000hrs

Protection **IP65**



ETL US

Modèle	Degré Kelvin	Nbr de LED	Consommation	Optiques	Dimensions	Flux Lumineux
LWRI-2ft	R,G,B,WW,NW,W	72pcs	70 WATTS	10°, 15°, 20°, 30°, 45°, 60°, 15x55°	L640xW148xH176mm	2000lm
LWRI-4ft	R,G,B,WW,NW,W	144pcs	140 WATTS	10°, 15°, 20°, 30°, 45°, 60°, 15x55°	L1240xW148xH176mm	3350lm

DEGRÉ KELVIN



3000K



4000K

Red **Green**

Rouge Vert

Blue **RGB**

Bleu RGB

OPTIONS DE COMMANDE

Rio

Code de Produit	Longueur	Degré Kelvin	Optiques	Options de Contrôle
LWRI	----	---	-----	-----
	25IN - 25in	30K - 3000K	10 - 10°	DMXC - Contrôle DMX
	49IN - 49in	40K - 4000K	15 - 15°	OOC - Contrôle On/Off
		RD - Rouge	20 - 20°	
		GN - Vert	30 - 30°	
		BLU - Bleu	45 - 45°	
		RGB - RGB	60 - 60°	
			15x50 - 15° x 50°	

Informations de Commande Supplémentaires

Notes |

Dimensions

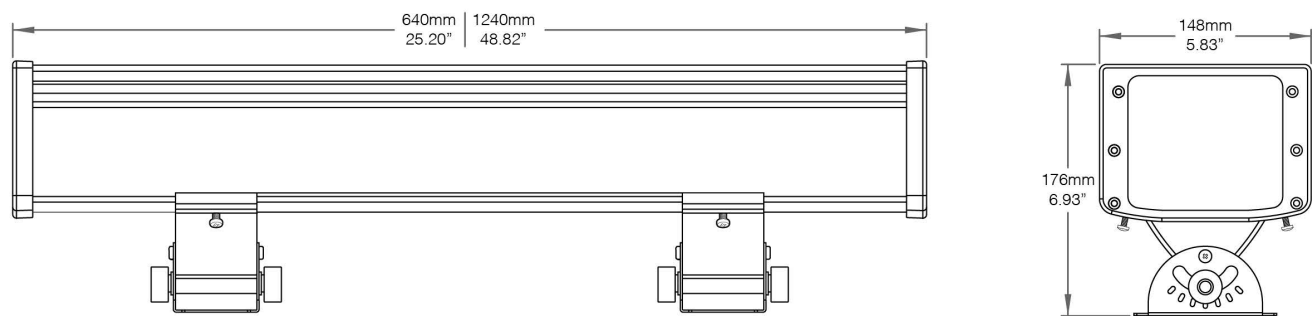

Support de Montage

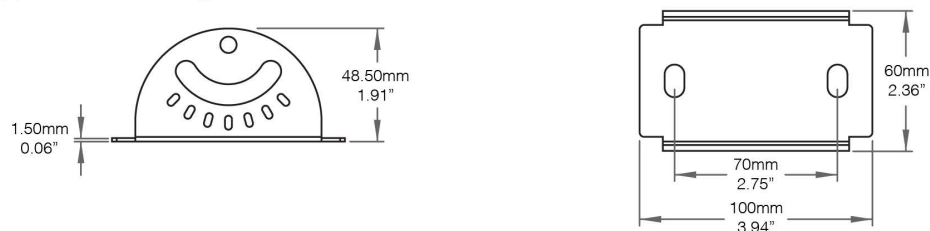

Paramètres Photométriques

LWRI-25in

Beam Angle:10°

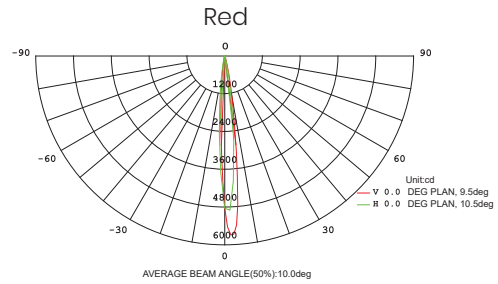
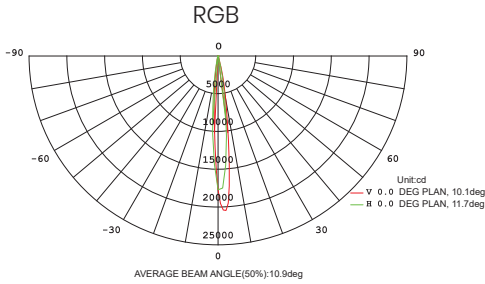
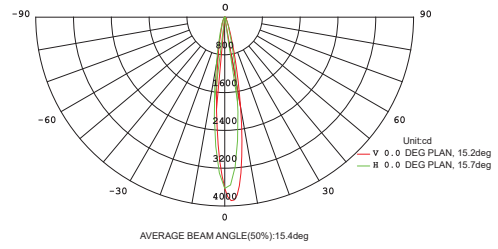
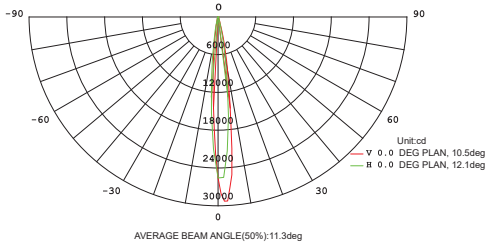

Green

Blue

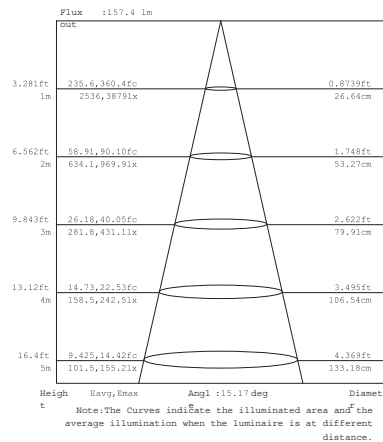
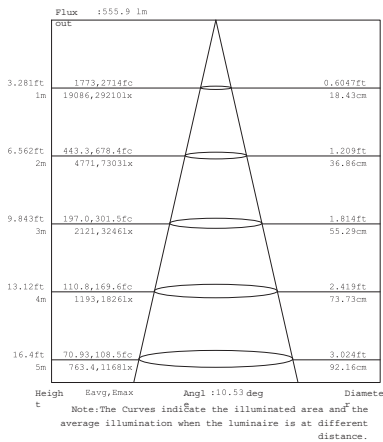

RGB

Red

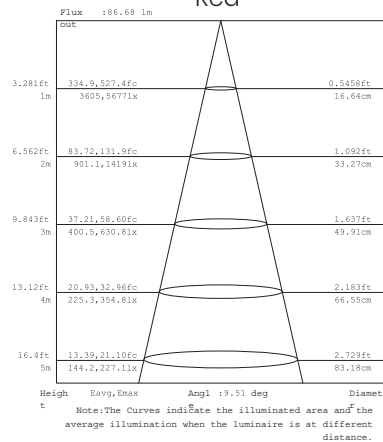
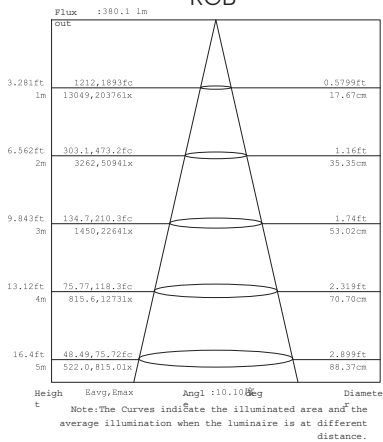

Green

Blue