

NOM DU PROJET

TYPE

QTÉ

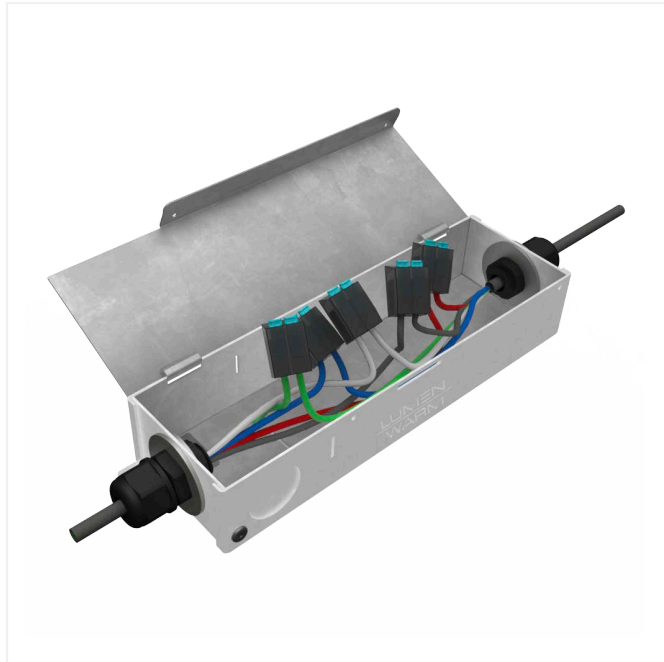

## BOÎTE DE JONCTION

- Fait d'aluminium
- Deux grandeurs différentes pour répondre à vos besoins
- Peut contenir un transformateur
- Permet de raccorder des fils en toute sécurité

Protection  
**IP20**Protection  
**IC**

### Dimensions

#### Boîte de Jonction JBX-20

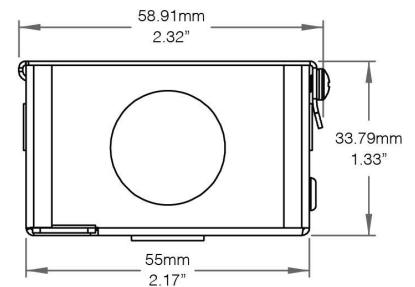
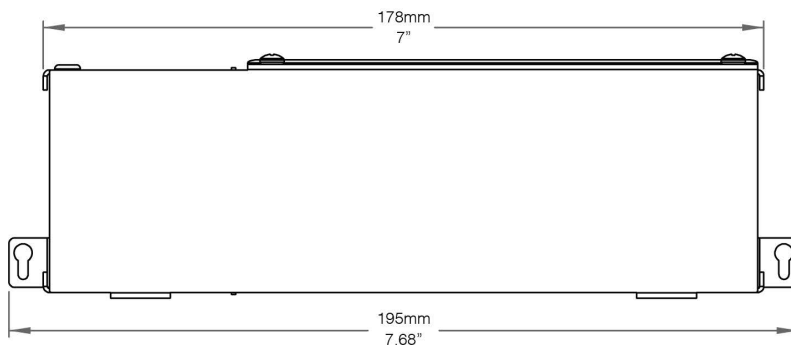

#### Boîte de Jonction JBX-80

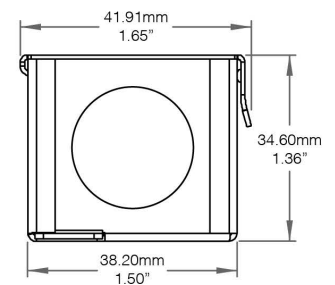
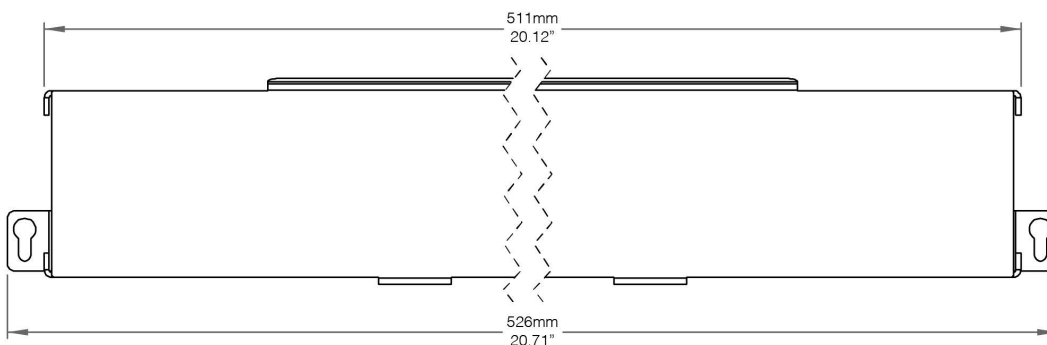

Accessoires - À commander séparément

### Borne de Raccordement

#### 2 Positions

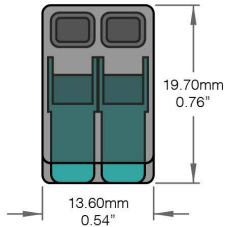

SCNT-2P-0001

#### 3 Positions

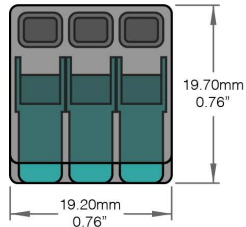

SCNT-3P-0001

#### 5 Positions

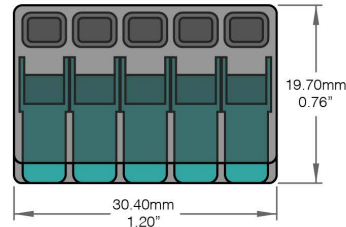

SCNT-5P-0001

#### Vue de Côté

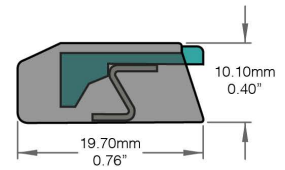

### Passer-Fil 40mm - M12-1.5 et Rondelles Plates

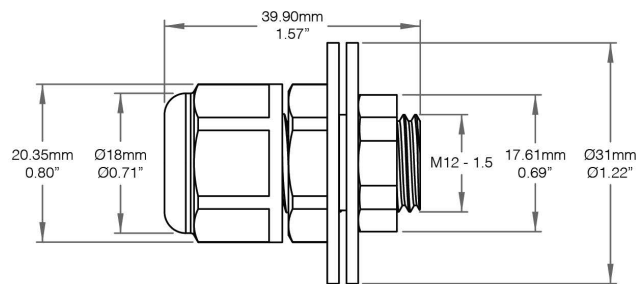

Noir: KPTW-018040-M12-BK-2W-0001

Blanc: KPTW-018040-M12-WH-2W-0001

## Tableau de Commande

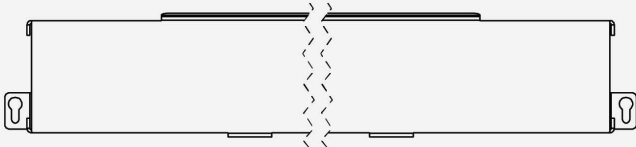
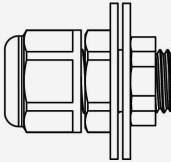
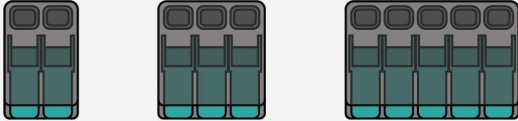
Accessoires	Code Produit	Quantité
 <p>Boîte de Jonction 20</p>	JBX-20-0001	
 <p>Boîte de Jonction 80</p>	JBX-80-0001	
 <p>Kit Passe-Fil M12-1.5 et Rondelles Plates</p>	Noir: KPTW-018040-M12-BK-2W-0001	
	Blanc: KPTW-018040-M12-WH-2W-0001	
 <p>Bornes de Raccordement</p>	2 Positions: SCNT-2P-0001	
	3 Positions: SCNT-3P-0001	
	5 Positions: SCNT-5P-0001	