

PROJECT NAME

TYPE

QTY

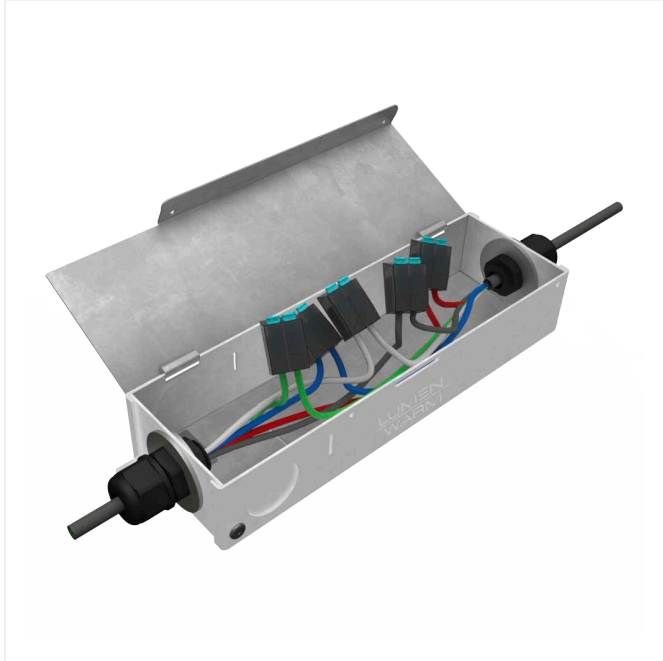

JUNCTION BOX

- Made of aluminum
- Two different sizes to meet your needs
- Can house a driver
- Allows to safely connect wires



Dimensions

Junction Box JBX-20

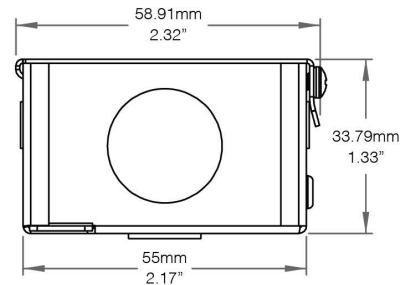
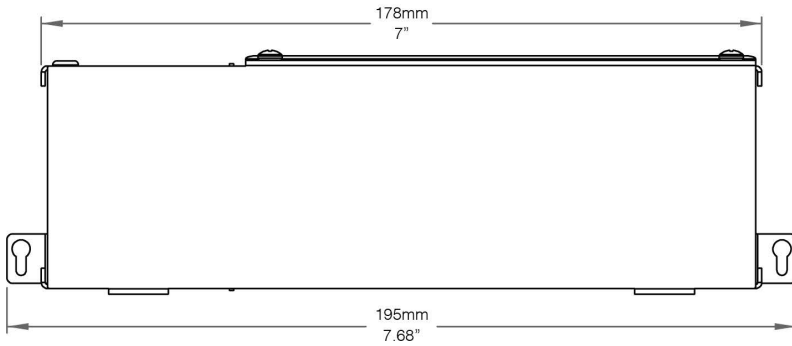

Junction Box JBX-80

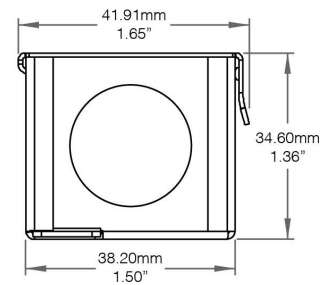
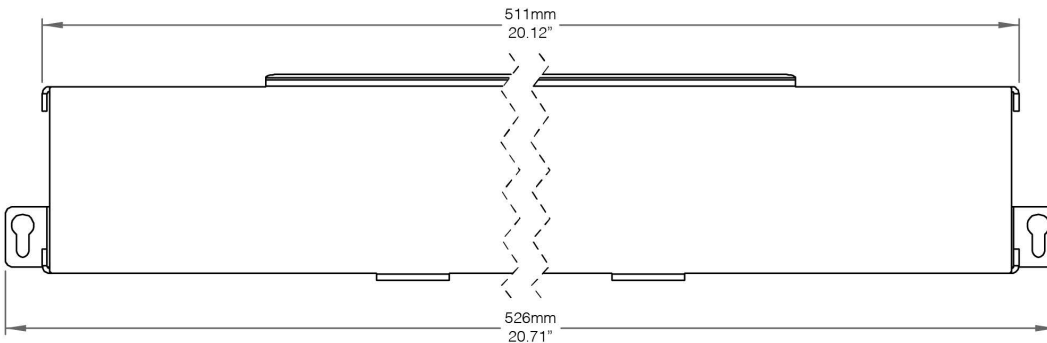

PROJECT NAME

TYPE

QTY

Accessories - Order Separately

Splicing Connector

2 Positions

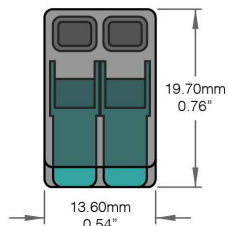

SCNT-2P-0001

3 Positions

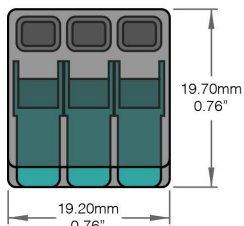

SCNT-3P-0001

5 Positions

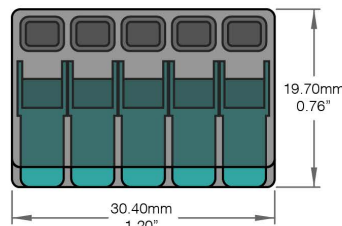

SCNT-5P-0001

Side View

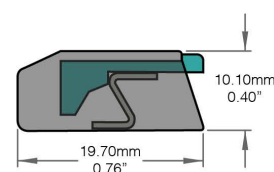

Pass-Through 40mm - M12-1.5 and Flat Washers

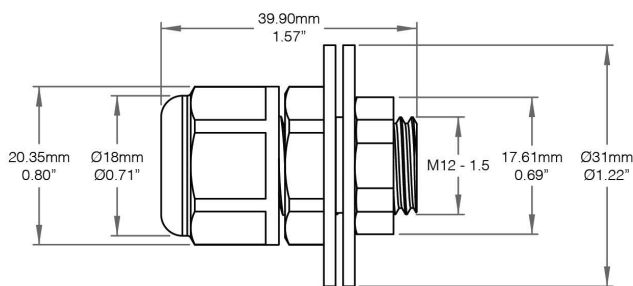

Black: KPTW-018040-M12-BK-2W-0001

White: KPTW-018040-M12-WH-2W-0001

PROJECT NAME

TYPE

QTY

Ordering Options

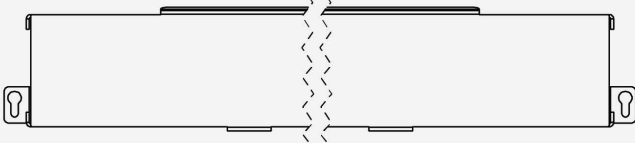
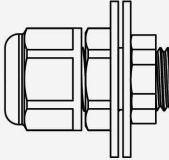
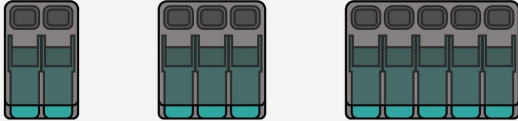
Accessories	Product Code	Quantity
 <p>Junction Box 20</p>	JBX-20-0001	
 <p>Junction Box 80</p>	JBX-80-0001	
 <p>Pass-Through M12-1.5 and Flat Washers Kit</p>	Black: KPTW-018040-M12-BK-2W-0001	
	White: KPTW-018040-M12-WH-2W-0001	
 <p>Splicing Connectors</p>	2 Positions: SCNT-2P-0001	
	3 Positions: SCNT-3P-0001	
	5 Positions: SCNT-5P-0001	