

LUMEN WARM



**EROS SUSPENDED
LWERS-SPD**



BROCHURE



INSTALLATION SHEET



Eros Suspended

The Eros conception allows you to create long linear runs to appropriately light up the space it is installed in. Custom lengths and patterns are also a possibility and with its fully lit corners, darkness will be a thing of the past



Performance

Direct			
Lm	Lens Type	W/ft	Lm/W
300	Lambertian	2.4	125
750		6.1	122
1000		8.8	114
750	Multicell 12° Module	5.1	147
750	Multicell 24° Module	5.1	147
750	Multicell 38° Module	5.1	147
750	Multicell 50° Module	5.1	147
750	Multicell 35°X70° Module	5.1	147

Indirect			
Lm	Lens Type	W/ft	Lm/W
1000	Lambertian	4.8	408
750	60°	3.3	233
750	90°	3.3	233
750	Asymmetric	3.3	233
750	Batwing	3.3	233

Please note this information is based on a 1ft / 4000K fixture.

Highlights

Lumen Output	Up to 1100lm/ft Deliver lumen with lambertian lens.
Efficiency	Up to 145lm/W
Colour Temperature	2700K, 3000K, 3500K, 4000K
CRI	90
Input Voltage	Integral driver, 100-277VAC
Dimming Options	0-10V (Down to 1%), Lutron Ecosystem, Dim to Off
Lead In	Up to 80ft maximum run per power feed (15A /1650W maximum).

Dimensions

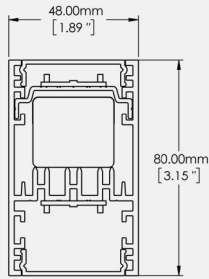

Distribution

Direct

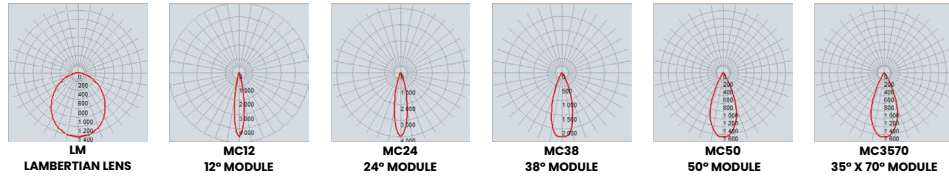

Indirect

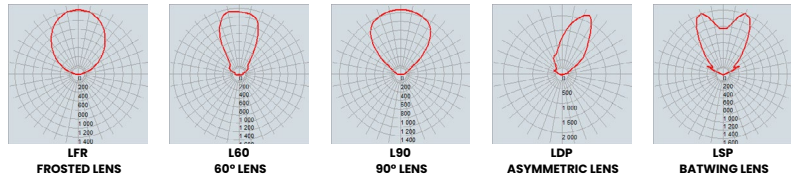

Configuration Example

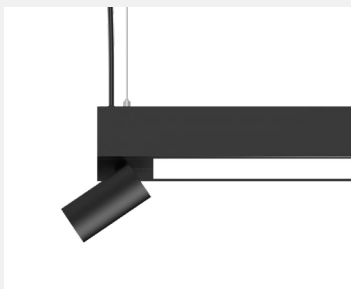

ACCENT SPOTLIGHT

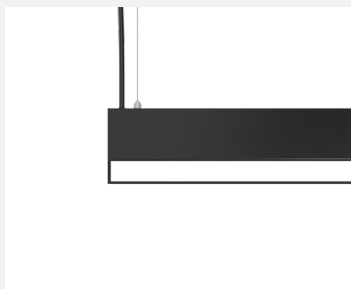

LAMBERTIAN MODULE

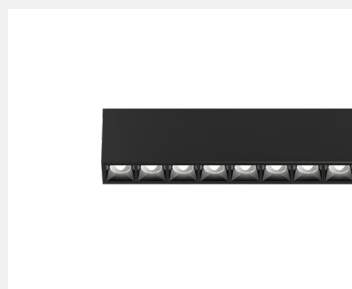

MULTICELL MODULES

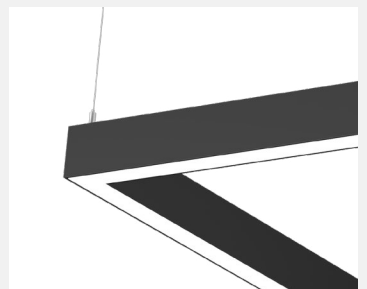

PATTERNS
MULTIPLE OPTIONS

Ordering Sections	Technical Information	Controls	Mounting Options	Emergency	Photometrics Data
-------------------	-----------------------	----------	------------------	-----------	-------------------

Eros Suspended

Ordering Guide

Ex : LWERS-SPD-48-NA-MBK-MC12-DCH-P300

Product Code	Length	Pattern Type	Pattern Dimensions	Exterior Finish	Direct Linear Modules (3)	Multicell Finish	Direct Linear Modules Lumen Package
LWERS-SPD							
48 48in 60 60in 72 72in 84 84in 96 96in 144 144in CUCR Custom Continuous Run CUSU Custom Single Unit CUPA Custom Pattern	PAL L-Shaped Pattern PAS Square Shaped Pattern PAU U-Shaped Pattern PAT T-Shaped Pattern PAX X-Shaped Pattern PAH H-Shaped Pattern CU Custom Shaped Pattern (1) NA None	A X B A X B A1+A2 X B A X B X C A1+A2 X B1+B2 A X B1+B2 X C1+C2	MBK Matte Black MWH Matte White CU Custom (2)	LM High Efficiency Lambertian Lens MC12 12° MC24 24° MC38 38° MC50 50° MC3570 35° x 70° NA None	DCH Dark Chrome MBK Matte Black MWH Matte White CU Custom NA None	P300 300lm/ft P400 400lm/ft P600 600lm/ft P700 700lm/ft P900 900lm/ft P1100 1100lm/ft CU Custom Output (4)	
Refer to the 'Technical Information' section for further details.		(1) A drawing will be needed for custom shapes. Refer to next page for more details on available shapes.		(2) Specify RALK7 code.	(3) Full length direct light module (1 choice of direct module only)	*The Multicell Module (MC) option is required to select this option*	(4) Consult factory for more information.

Ex : 27K-ULFR-P300-27K-BKD-FRG-MBK-9SK

Direct Colour Temperature	Indirect Linear Modules	Indirect Lumen Package	Indirect Colour Temperature	Power Cable Colour	Canopy and Finish	Accessories
27K 2700K 30K 3000K 35K 3500K 40K 4000K TU Tunable White CU Custom (5)	ULFR High Efficiency Lambertian Lens UL60 60° Focus Lens UL90 90° Focus Lens ULDP Asymmetric Lens ULSP Batwing Lens NA No Indirect Module (6)	P300 300lm/ft P400 400lm/ft P600 600lm/ft P700 700lm/ft P900 900lm/ft P1100 1100lm/ft CU Custom Output (7) NA None	27K 2700K 30K 3000K 35K 3500K 40K 4000K TU Tunable White CU Custom (8) NA None	BKD Black Decorative Cable MWH White Decorative Cable	FRD-MBK Matte Black Round FRD-MWH Matte White Round FRG-MBK Matte Black Rectangle (9) FRG-MWH Matte White Rectangle (9) CU Custom (10)	3SK 3ft Adjustable Suspension Kit 9SK 9ft Adjustable Suspension Kit 20SK 20ft Adjustable Suspension Kit CUSK Custom Length (11)
(5) Consult factory for more information.	(6) A colour matching cover will be used to protect the inside components if no indirect lighting is required	(7) Consult factory for more information.	(8) Consult factory for more information.		(9) Rectangular Canopy is compatible with GB2020 Junction box models. Refer to the "Mounting Options" section for details. (10) Specify the desired canopy and the RALK7 code.	(11) Specify cable length.

Ex : IHC-NA-UNI-X10V-1C-NA-AWNR

Mounting	Optional Accent Spotlights (12)	Voltage	Driver	Circuits (16)	Emergency (17)	Controls (18)
916 9/16 T-Grid Clip 1516 15/16 T-Grid Clip IHC Hard/Drywall Ceiling	1BGL Single Unit, Power Feed Side 1BGO Single Unit, Opposite Side 2BGE Two Units at Extremities NA None	UNI Universal 100-277V 347 347V (13)	X10V 0-10V Driver 1% Z10V 0-10V Driver Dim to Off DA2 Dali 2.0 (14) LTI Lutron Hi-Lume 1% OTH Other (15)	1C One Circuit 2C Two Circuits CU Custom	B6W Integral Battery Pack 6W B10W Integral Battery Pack 10W NA None	AWNR Athena Wireless Node RF Only AWNS Athena Wireless Node RF + Occupancy Sensor NA None
	(12) See P.5 for more ordering details and sketch/drawing for spotlight placement.	(13) Requires 0-10V driver.	(14) Dali driver commissioning is required. (15) Consult factory for more information.	(16) Refer to the "Controls" section for more details.	(17) Provide a sketch/drawing for the positioning of the emergency section. Refer to the "Emergency" section for further details. (Not compatible with 347V).	* Only one Node per Circuit.* (18) Athena not compatible with 347V.

Notes

Patterns

Base Information

Description	The Eros family offers 3 standard connector shapes for different pattern configurations. Every connector is welded in factory and is fully illuminated, ensuring consistent lighting for seamless installation.
Dimensions	L-Shaped Connector : 7.5in x 7.5in / 190.5mm X 190.5mm
	T-Shaped Connector : 7.5in x 13.75in / 190.5mm X 332mm
	X-Shaped Connector: 13.75in x 13.75in / 332mm X 332mm

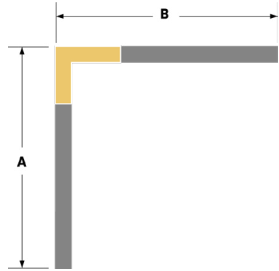
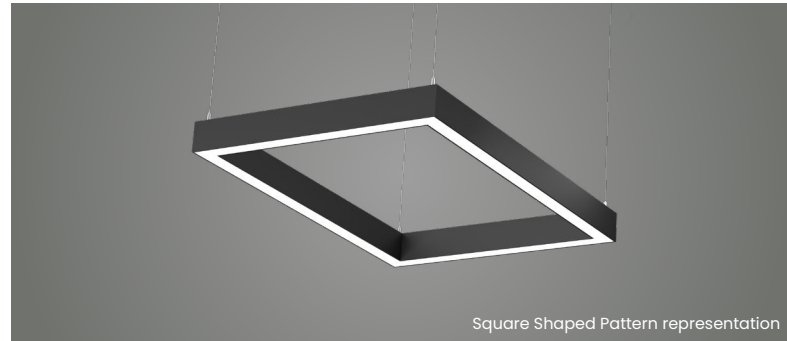

L-Shaped Pattern	
A	B
36in Minimum length	
$PAL = A \times B$	

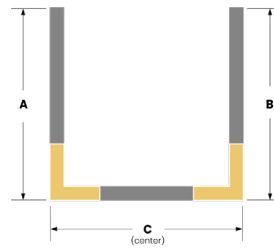

U-Shaped Pattern		
A	B	C
36in Minimum length		42in Minimum length
$PAU = A \times B \times C$		

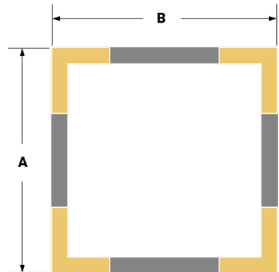

Square Shaped Pattern	
A	B
42in Minimum length	
$PAS = A \times B$	

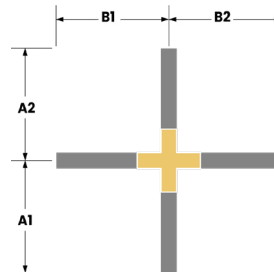

X-Shaped Pattern			
A1	A2	B1	B2
36in Minimum length			
$PAX = A1 + A2 \times B1 + B2$			

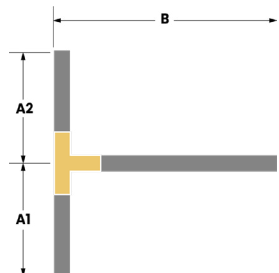

T-Shaped Pattern		
A1	A2	B
42in Minimum length		36in Minimum length
$PAT = A1 + A2 \times B$		

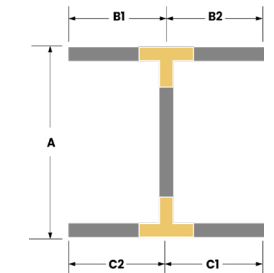

H-Shaped Pattern				
A	B1	B2	C1	C2
42in Minimum length	36in Minimum length			
$PAH = A \times B1 + B2 \times C1 + C2$				

Workshop Drawing

Use grid to draw Custom Pattern

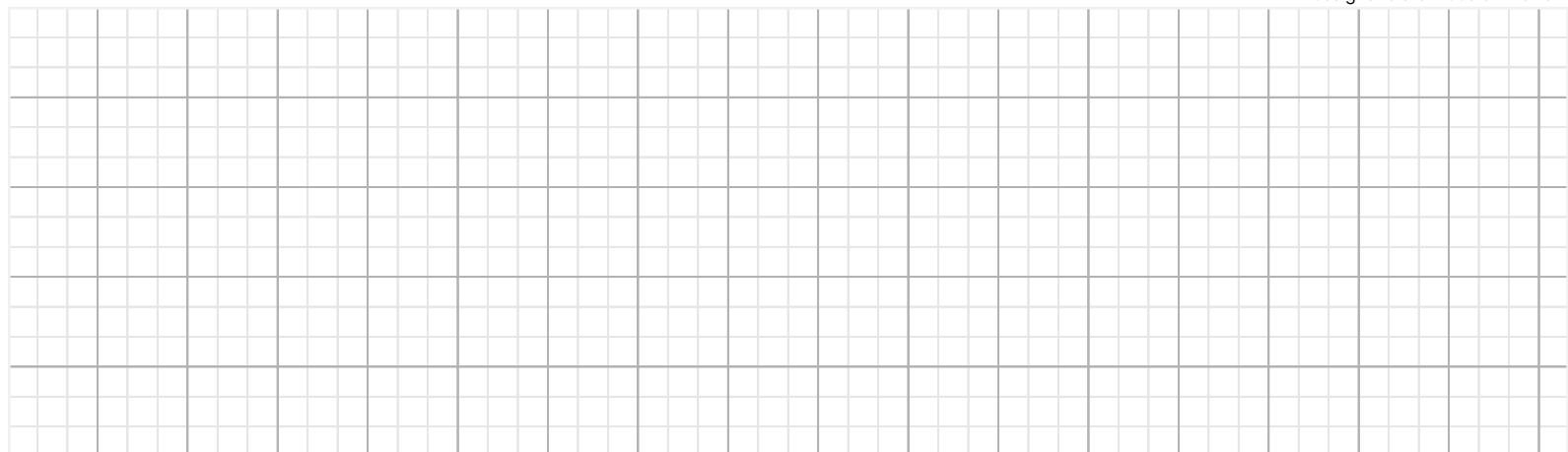

Accent Spotlights

Ordering Options

Example : 1BGL-MBK-P400-27K-16-NA-IC

Product Code	Spotlight Code	Finish	Lumen Package	Colour Temperature	Optics	Accessories	Circuit
LWERS							
1BGL	Single Unit, Power Feed Side	MBK	P400	27K	16	DIFF	IC
1BGO	Single Unit, Opposite Side	MHW	P800	30K	26	HL	DC
2BGE	Two Units at Extremities			35K	36	NA	SC
NA	None			40K			
				CU			
							(1) Adds a circuit on the fixture, consult factory for more information.

Dimensions

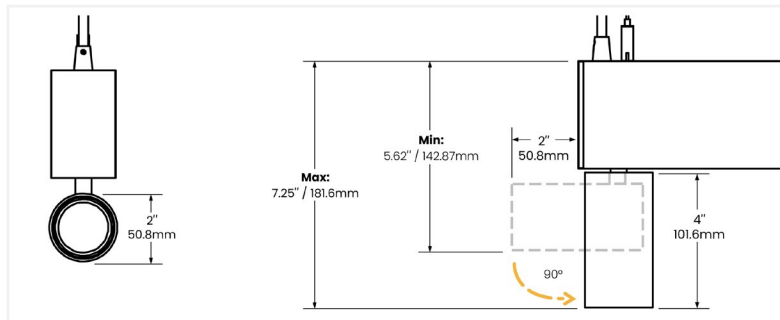

Performance

16° Optics

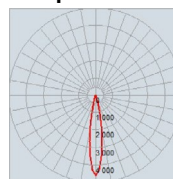

mA	Lumen	Power (w)	Lm/W
275	1200	9.75	118
350	1400	12.72	110
500	2000	19.00	98

26° Optics

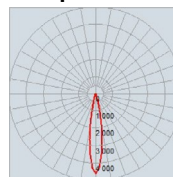

mA	Lumen	Power (w)	Lm/W
275	1200	9.75	120
350	1400	12.72	114
500	2000	19.00	101

36° Optics

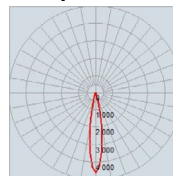

mA	Lumen	Power (w)	Lm/W
275	1200	9.75	123
350	1400	12.72	119
500	2000	19.00	105

Features

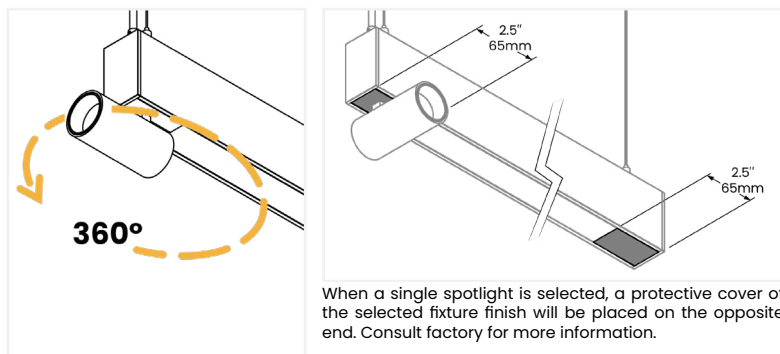

Accent Spotlight Positioning

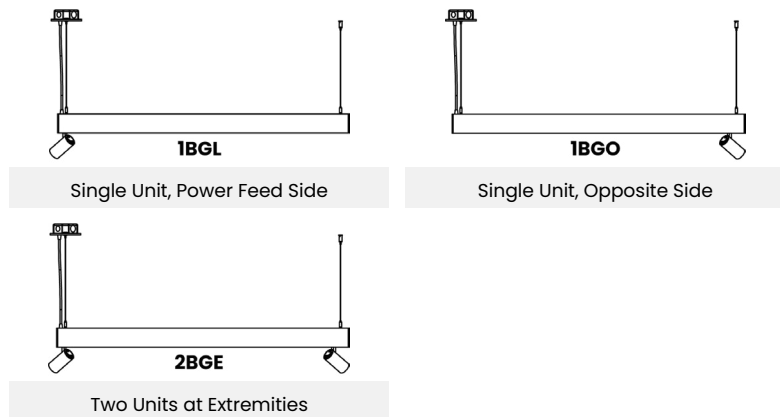

Technical Information

Construction

Aluminum Profile	100% Recycled Aluminum grade 6063-T5
Endcap	Aluminum grade 6063-T5, Extruded and machined part
Brackets	
High Efficiency Lambertian Lens	Frosted Acrylic, Extruded part
Suspension Cable	Stainless steel adjustable aircraft cable
Joiner	1060 Steel, 14 gauge

Aluminum Profile Colour

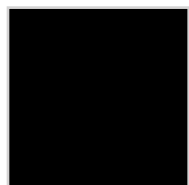

MBK - Matte Black

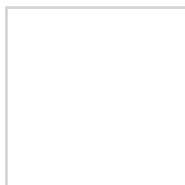

MWH - Matte White



CU - Specify RALK7 colour

Dimensions

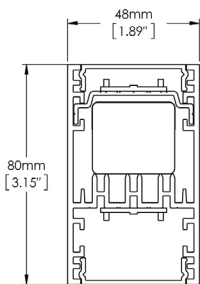

Indirect & Direct Lambertian Lens

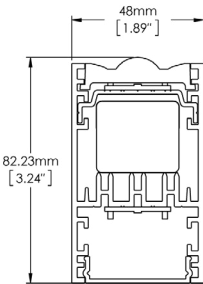

Indirect 60° Lens Direct Lambertian Lens

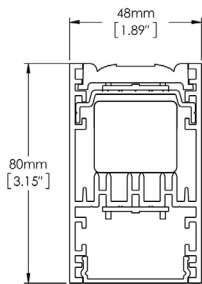

Indirect 90° Direct Lambertian Lens

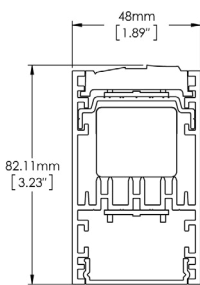

Indirect Asymmetric Lens Direct Lambertian Lens

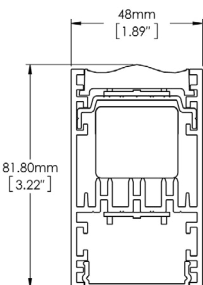

Indirect Batwing Lens Direct Lambertian Lens

Length Management



A	Minimum length for Eros is 4ft long. Eros longer than 8ft will have an additional cost for shipping purpose. Maximum length for one fixture is 12ft . Fixture over 12ft long will be split into sections (see Mounting Options section).
B	All Suspension cables are field adjustable in length.

Module Management

LM -High efficiency Lambertian Lens Module	
Dimensions	Maximum length for lens : 3657.6mm/144in Minimum length for lens: 152.4mm/6in
Management	Lambertian module must be calculated with \approx 152.4mm/6in increment to reduce dark spot risk.

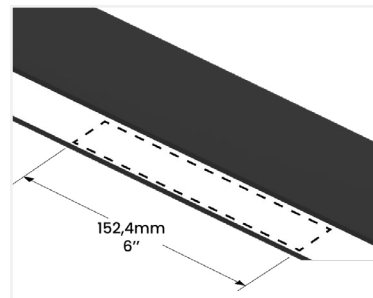

MCXX-Multicell Modules	
Dimensions	Direct Multicell module is \approx 190.5mm/7.5in
Management	Measure 190.5mm/7.5in increment when you plan your section in the fixture to avoid visible spacing.

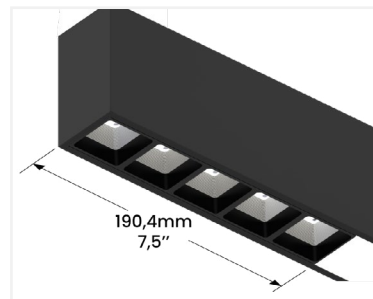

Multicell Optics



Driver

0-10V Driver 1%	Driver for maximum dimming capabilities. Provide a smooth dimming from 10% up to 0.1%, works on 347V only.
0-10V Driver Dim to Off	Driver that facilitates the control of dimming of maximum light power to off state, operates only on 347V.
Dali	Driver which allows the addressability of luminaires to be adapted individually or in groups. Its system facilitates the management of connections as well as its installation.
Lutron Hi-Lume 1%	The Hi-Lume LED driver is the world's first LED driver to offer smooth, continuous 1% dimming for virtually any LED fixture.  Lutron Hi-Lume 1% Spec Sheet
Other Driver	Other driver options are available. Consult factory for more information.

Circuits

1 Circuit

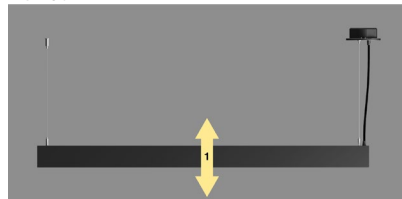

All lighting is on the same circuit and will be controlled simultaneously.

2 Circuits

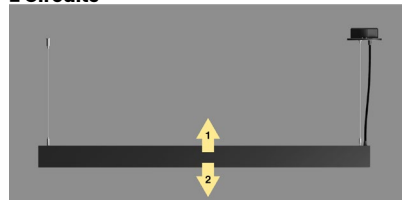

Direct and indirect lighting are on two separate circuits and will be controlled independently.

(CU) More than 2 Circuits

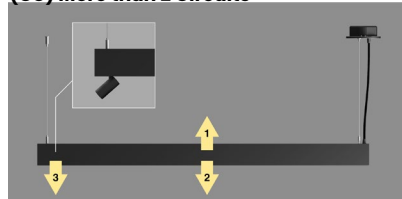

Direct and indirect lighting are on two separate circuits and will be controlled independently.

A third circuit is added to the fixture to specifically control the accent spotlight when the Separate Circuit (SC) option is selected in the Accent Spotlight ordering guide.

Athena Wireless Node

Models	AWNDR - Radio Frequency AWNS - Radio Frequency + Occupancy Sensor
Description	The Athena wireless node is a radio frequency (RF) device that enables simple, digital control of individual light fixtures in an Athena controlled system. The small size and compatibility with a wide variety of drivers allow for seamless integration with common commercial lighting fixtures from any manufacturer.
Driver Compatibility	Static White Control: <ul style="list-style-type: none"> • Lutron digital drivers (coming soon) • DALI-2 certified drivers • ANSI C137.1 compliant 0-10V drivers Tunable White Control: <ul style="list-style-type: none"> • Lutron digital drivers (coming soon) • DALI-2 certified drivers
Power / Load	<ul style="list-style-type: none"> • IEC SELV / NEC® Class 2 • Operating voltage: 9.5 - 28.8V • Operating current: 46mA max

Spec Sheet



Installation Documents



Finish

Node colour will match the fixture finish, if custom colour is selected, black node will be supplied unless specified otherwise.

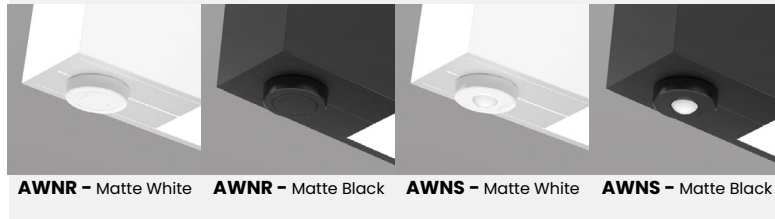

AWNDR - Matte White AWNR - Matte Black AWNS - Matte White AWNS - Matte Black

Mounting Options

Canopy Options

Round Canopy		
Code	FRD-MBK	FRD-MWH
Description	Matte Black Round Canopy	Matte White Round Canopy
Dimensions	Ø5inL x 0,28inH	
Boîte de Jonction	Compatible with the Standard octagonal model 4.5in x 4.5in	

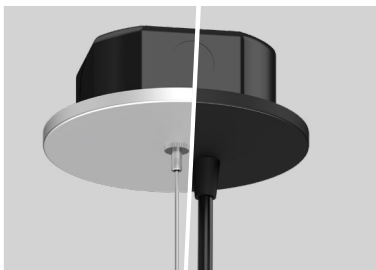

Rectangle Canopy		
Code	FRG-MBK	FRG-MWH
Description	Matte Black Rectangle Canopy	Matte White Rectangle Canopy
Dimensions	2.90inW X 6.55inL x 0.60inH	
Boîte de Jonction	Compatible with rectangular model: BC 1104LHT/1104L-CRT/GB 2020 or equivalent.	

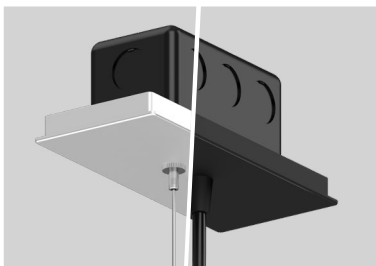

Detailed View

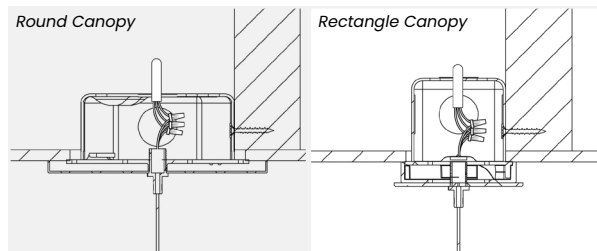

Canopy Options, Hard / Drywall Mounting :
With power feed cable

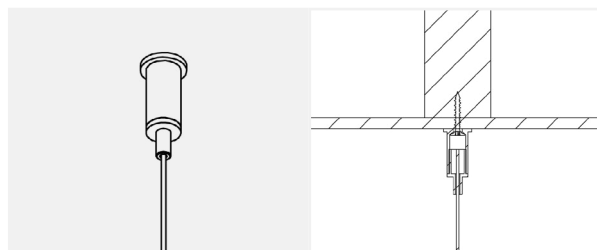

Hard / Drywall Mounting : No power feed cable

Canopy Installation



Canopy Installation Instructions
Consult our installation guide for more information.

Cable Colour



BKD
Black Decorative Cable
(Pass-Through Is Matte Black)



WHD
White Decorative Cable
(Pass-Through Is Matte White)

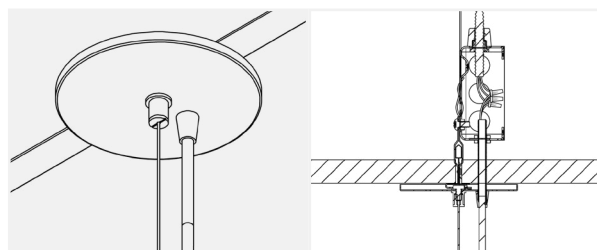

Round Canopy on T-Grid: With power feed cable

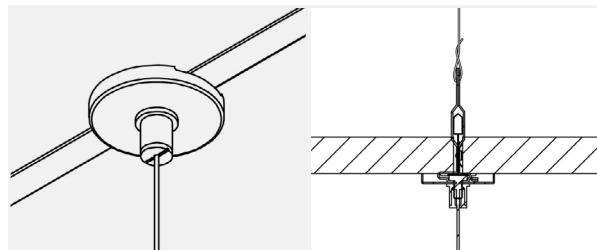

9/16 Clip for T-Grid : No power feed cable

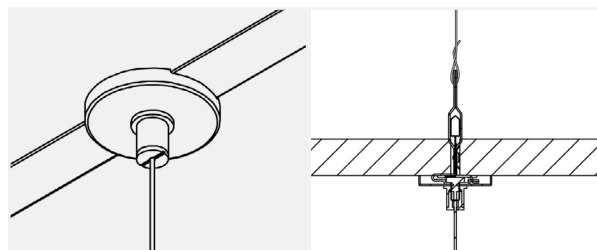

15/16 Clip for T-Grid: No power feed cable

Dimensions

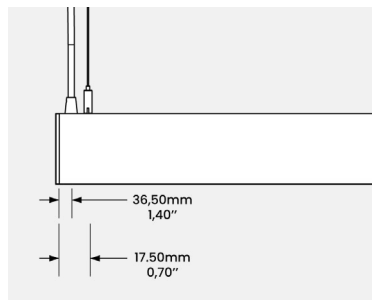

Power feed cable and adjustable aircraft cable measurement from edge.

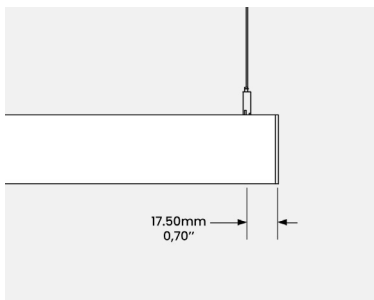

Adjustable aircraft cable measurement from edge.

Joiner Information

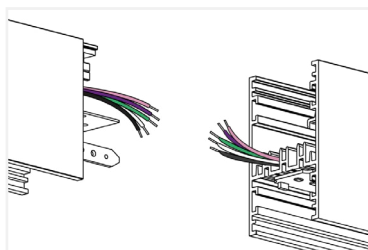

Align the Fixtures

Connect the wires/pin connector and use steel aligners to fuse sections. **Splicing connectors are included for the section connection**

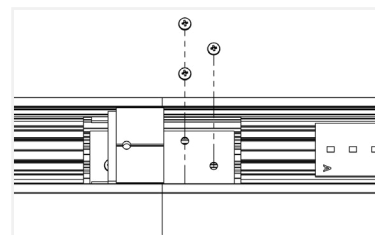

Secure the Fixtures

Secure the two fixtures together by tightening the screws of the joining plate.

Suspension Cable Options

Fixture Single Unit



Suspension Cables	Only two suspension cable are needed for this options.
Weight	Eros weight /feet : 1.5lbs

Fixture Multiple Sections

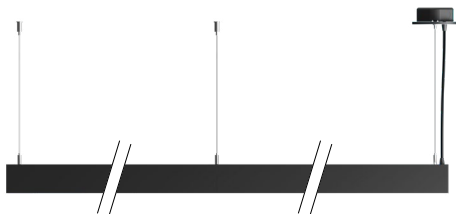

Suspension Cables	For each section, an additional suspension cable will be added at its junction.
Custom Length	Contact our factory for more information on custom length and its specifications.

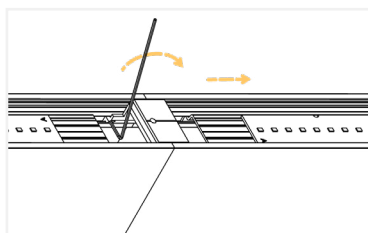

Secure the Alignment

Tighten the set screws with an Allen key to secure the fixture's alignment.



Single Unit Installation Guide

Consult our installation guide for more information.



Multiple Sections Installation Guide

Consult our installation guide for more information.

Emergency

Description

Ordering Code	Battery				Illumination Time	Fixture		
	Model	Weight	Input Current	Output Power		Lumen Output	Voltage Range	Minimum Length
B6W	BSL06T3	0.95lbs (0.43Kg)	60mA	6W	90min	Up to 900lm (Based on a efficiency of 150lm/w)	120-277 VAC, 50/60 HzW	4ft
B10W	BSL10T3	1.05lbs (0.48Kg)		10W		Up to 1500lm (Based on a efficiency of 150lm/w)		
Notes	All data is based on a 4ft fixture.							

Documentation

B6 - BSL06T3

B10 - BSL10T3



Specification Sheet



Specification Sheet



Instruction Sheet

Circuit Management

* The diagram presented is directly referenced in the Bodine emergency battery documentation.*

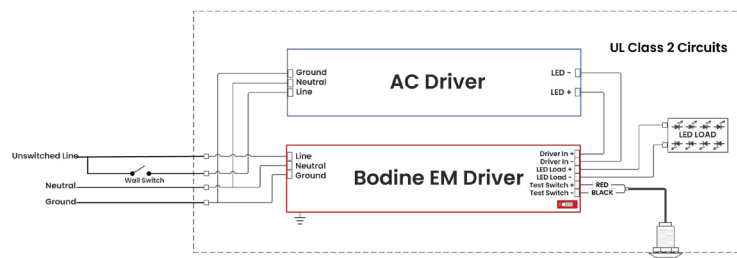

Emergency Section Management

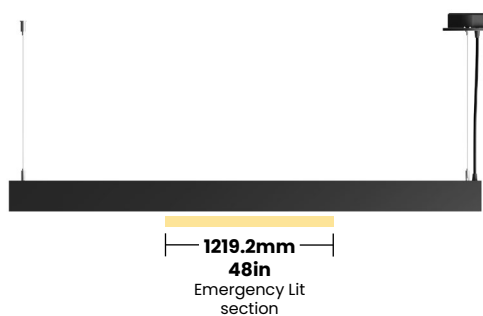

Provide sketch/drawing for emergency section positioning.

Minimum section must be at least 48in.

Workshop Drawing

Use grid to draw combination



Light Colour Data

2700K					
Full Output	CIE		TM-30		
	R _a	94.4	91.5	R _f	
	R _g	100.0	100.0	R _g	

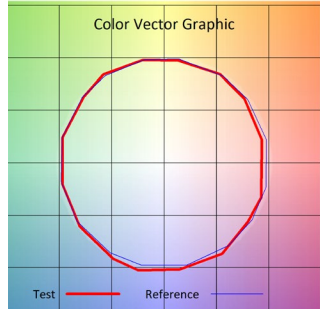

3000K					
Full Output	CIE		TM-30		
	R _a	93.5	90.8	R _f	
	R _g	99.8	99.8	R _g	

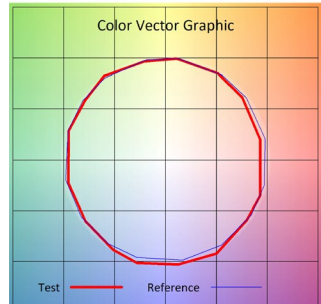

3500K					
Full Output	CIE		TM-30		
	R _a	93.9	89.0	R _f	
	R _g	97.4	97.4	R _g	

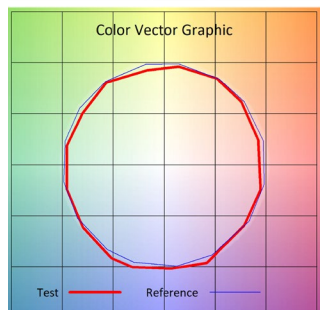

4000K					
Full Output	CIE		TM-30		
	R _a	93.1	89.9	R _f	
	R _g	99.0	99.0	R _g	

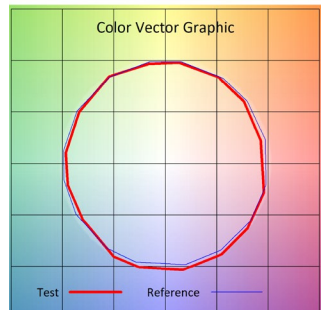

Eros IES



Light Loss Factor

4000K	0%
3500K	8%
3000K	17%
2700K	21%
2400K	24%
1800K	26%