

220lm/ft Tunable White LED Strip

Lumen Warm's Dynamic Colour series is a range of LED strips that offer Dim to Warm, Tunable White and RGBW variable colours options. They offer 90+ CRI, two Dim to Warm ranges of 1800K-3000K and 2700K-4000K and a wide range of colours to choose from using the Tunable White or the RGBW LED strip options.



Highlights

Colour Temperature	Tunable White 1800K - 3000K Tunable White 1800K - 4000K
CRI*	95+ 2 Step MacAdam Ellipse
Lumen Output	219lm/ft 720lm/m
Lumen/Watt	72lm/W
Driver	Remote Driver; 100~277V

*Please note this information is based off a 4000K LED Source.

Input Voltage	24VDC
Consumption	3.05W/ft 10W/m
Dimming Options	DMX, DALI DT8 + ATHENA NODE, DALI DT8 & LUTRON
Mounting	3M VHB premium quality double side tape
Applications	Dry or damp environment, low output light fixtures, millworks, cove, shelves, displays and much more.

*Please note this information is based off a 4000K LED Source.

Technical Information

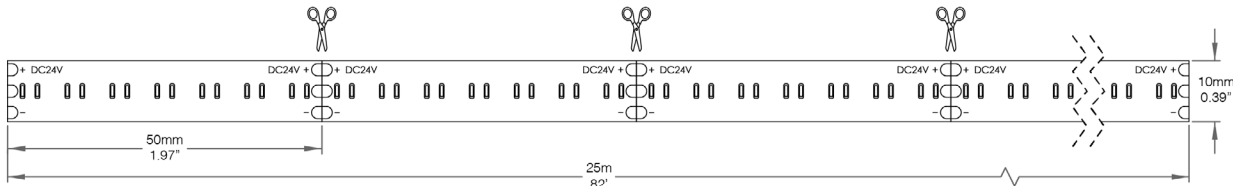

Ordering Options

Ex : LWTW220-5m-ADJ5-NA-NA

Product Code	Length	Colour Temperature	Lead In	Lead Out
LWTW220				
	5m 25m CU Custom (0)	ADJ4 Tunable White (1800K - 3000K) ADJ5 Tunable White (1800K - 4000K) CU Custom	DC7IN FT6 DC Quick Connect 7in DC3FT FT6 DC Quick Connect 3ft FT43FT FT4 Cable 3ft CUCBL Custom Cable NA None (1)	DC7IN FT6 DC Quick Connect 7in DC3FT FT6 DC Quick Connect 3ft FT43FT FT4 Cable 3ft CUCBL Custom Cable NA None (2)
	(0) Specify length & unit of measurement		(1) Refer to the following pages to select LED Strip Connectors, Junction Boxes & Wire Connectors.	(2) Refer to the following pages to select LED Strip Connectors, Junction Boxes & Wire Connectors.

Colour Temperature

Tunable White
(1800K - 3000K)

Tunable White
(1800K - 4000K)

Custom

Light Loss Factor per Colour Temperature	Maximum Run per Driver
4000K	0% 30W 8.21ft 2.5m
3500K	8% 60W 16.41ft 5m
3000K	17% 75W 20.51ft 6.25m
2700K	21% 96W 26.25ft 8m
2400K	24%
1800K	26%

* Tape must be refeed every 30ft max to avoid voltage drop. *

Technical Information

Parts Layout - LED Strip Connectors

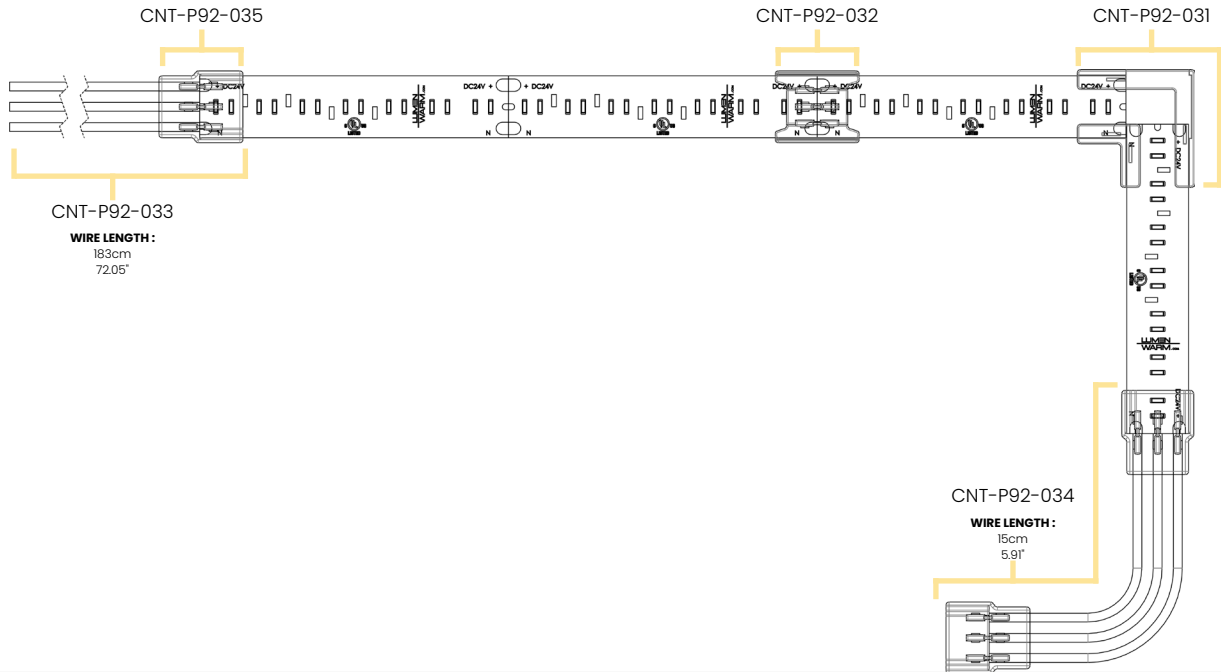

Dimensions

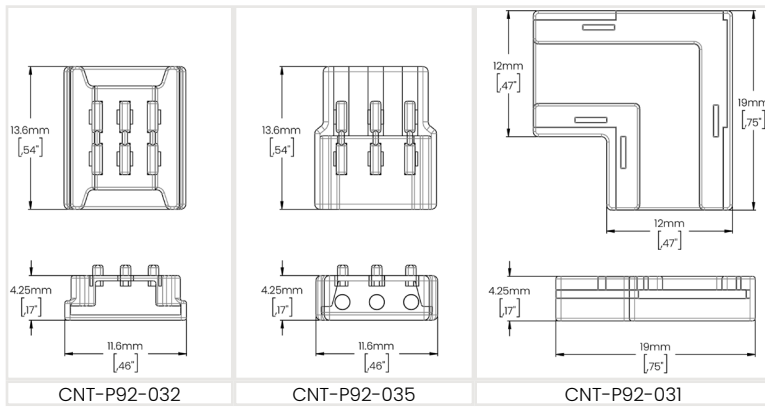

Ordering Options

LED Strip Connectors			
Code	CNT-P92-031	Quantity	
Code	CNT-P92-032	Quantity	
Code	CNT-P92-033	Quantity	
Code	CNT-P92-034	Quantity	
Code	CNT-P92-035	Quantity	

Workshop Drawing

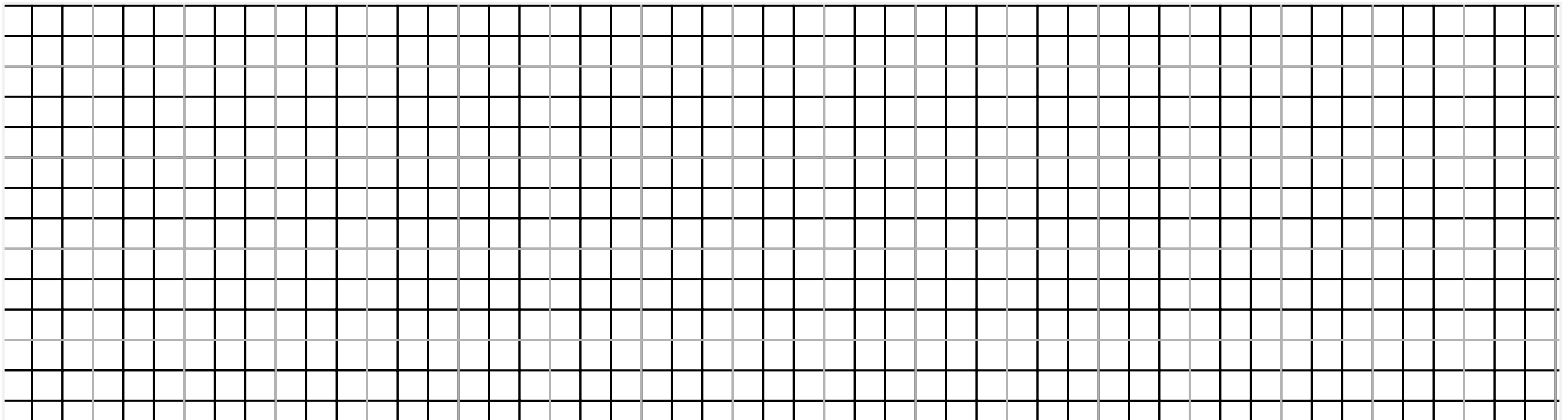

Technical Information

Parts Layout - Wire Connector

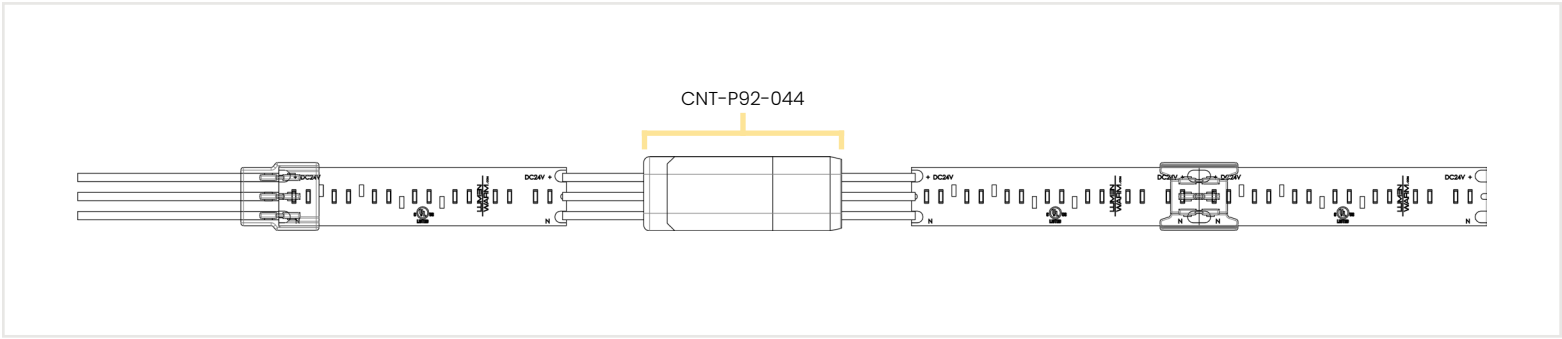

Specifications

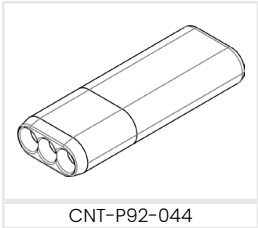

Rated Voltage	300V
Rated Current	9A
Working Environment Temperature	14°F ~ 113°F / -10°C ~ 45°C
Temperature Resistance	221°F / 105°C
Flame Retardant Grade	Complies with UL-94-V0
Conductor Cross Section	18 ~ 22AWG / 0.0012 - 0.00054in ²
Max. Insulation Outer Diameter	Ø0.083in

Dimensions

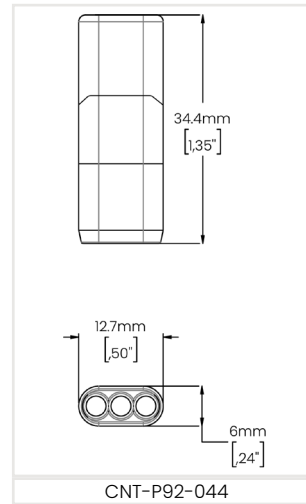

Ordering Options

Wire Connectors		
Code		Quantity
CNT-P92-044		

Workshop Drawing

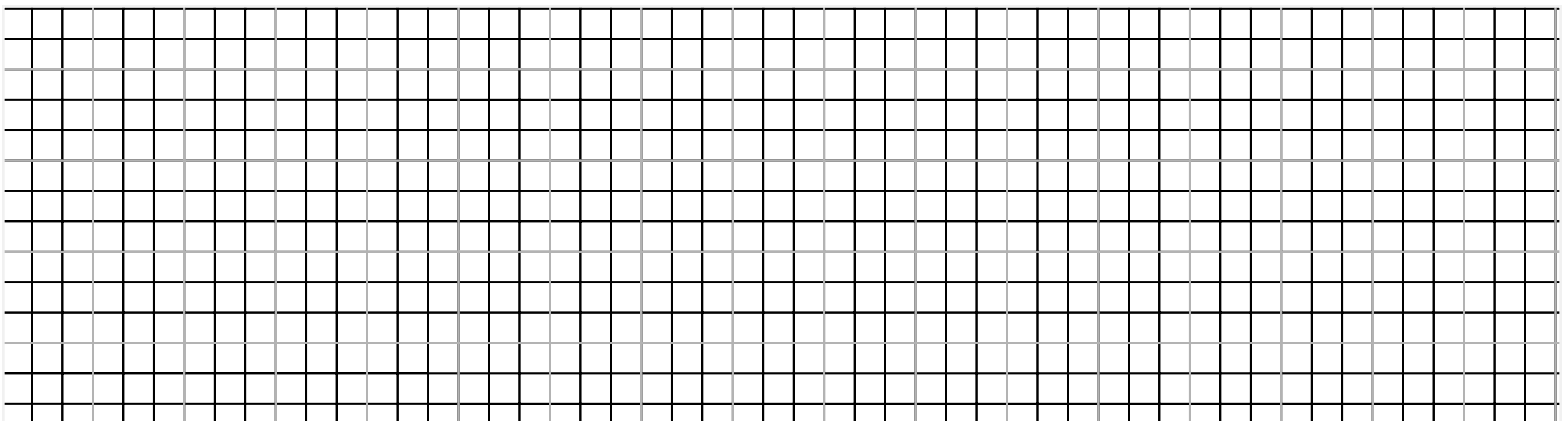

Compatible Drivers

DMX Drivers



Specifications	
Input Range: 100-277VAC	24V Constant Voltage Output, Class2
IP66 Waterproof design	Efficiency up to 89%
Downloads (Click cells for linked documents)	
100W	

Dali DT8 + Athena Node Lutron



Specifications	
ENEC & UL approved	Range 100-277VAC
Output constant voltage (NFC regulation)	Standby power consumption ≤0.5W
Downloads (Click cells for linked documents)	
96W	Lutron Athena Node

Dali DT8



Specifications	
ENEC & UL approved	Range 100-277VAC
Output constant voltage (NFC regulation)	Standby power consumption ≤0.5W
Downloads (Click cells for linked documents)	
96W	

Compatible Products

Click on product names for more information.

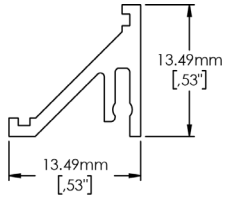

CONNOR

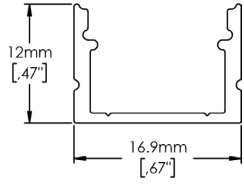

DOBY

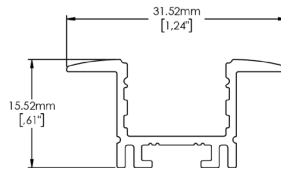

JAXSON

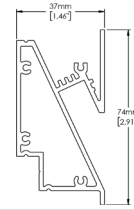

MYLA

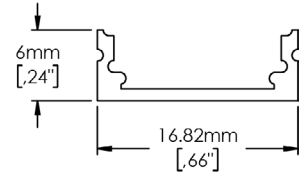

OLIVIA

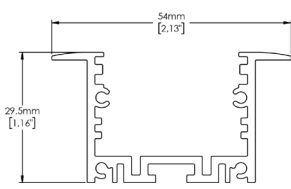

PALAZO MASTER

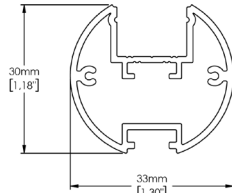

POLA

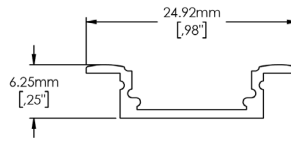

ROBERTHA

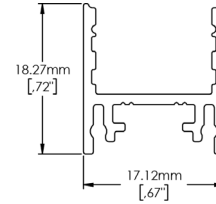

ROCCO

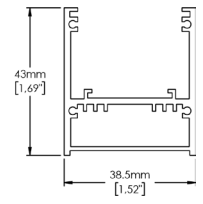

VENGA

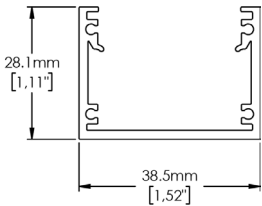

VENGA SLIM

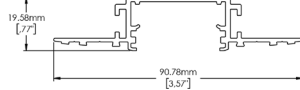

VENGA SLIM TRIMLESS

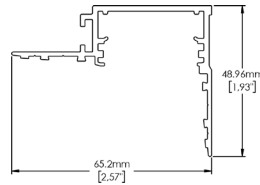

VENGA SLIM TRIMLESS PERIMETER

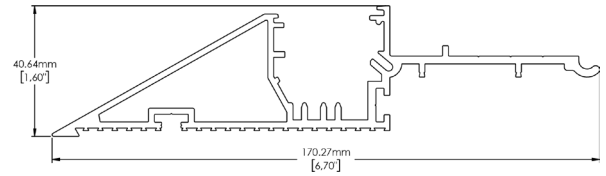

ARKALUX